

TX-BRWG2A120-101D

PRODUCT SPECIFICATION

Approved by:

Checked by:

Prepared by:

Part No.	TX-BRWG2A120-101D	Spec No.	WKF-BA8003	Page	1 of 8
-----------------	-------------------	-----------------	------------	-------------	--------



Features:

- ◆ Excellent Transiting Heat from LED Chip Operating under 300mA
- ◆ High Luminous Output
- ◆ No UV

Typical purpose:

- ◆ Portable Flashlight
- ◆ Garden lighting
- ◆ General Lighting

Package Dimensions:

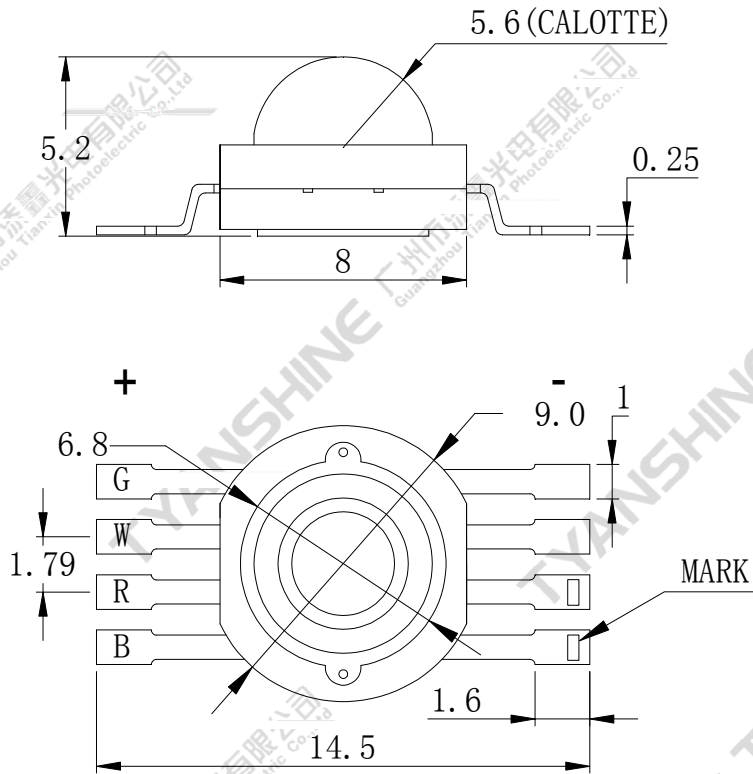

Part No.	TX-BRWG2A120-101D	Spec No.	WKF-BA8003	Page	2 of 8
-----------------	-------------------	-----------------	------------	-------------	--------

Notes:

Notes
000 0 c00 0 s1
028.2(000 0 (s)

- 1.All dimensions are in millimeters (inches).
- 2. Tolerance i0.44999 0 0 10.44999 54.33826 705.23149 cm 1.00000 0 0 1.00000 0 0 99 0 0212s1 cs 0 0 0 scr

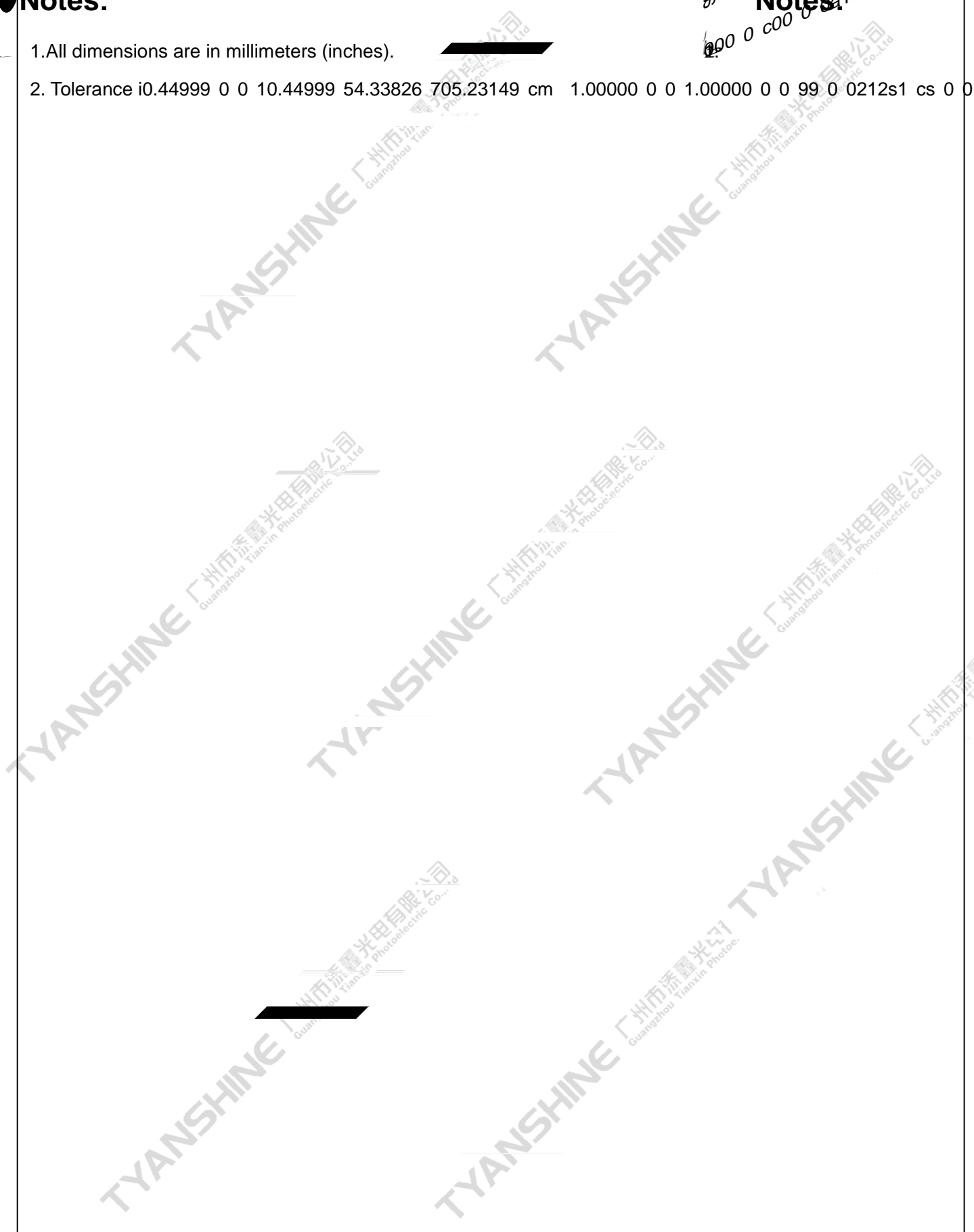

Part No.	TX-BRWG2A120-101D	Spec No.	WKF-BA8003	Page	3 of 8
----------	-------------------	----------	------------	------	--------

TYANSHINE 广州市添鑫光电有限公司
Guangzhou Tianxin Photoelectric Co., Ltd

TYANSHINE 广州市添鑫光电有限公司
Guangzhou Tianxin Photoelectric Co., Ltd

TYANSHINE 广州市添鑫光电有限公司
Guangzhou Tianxin Photoelectric Co., Ltd

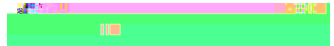

Typical Electrical / Optical Characteristics Curves

(25°C Ambient Temperature Unless Otherwise Note)

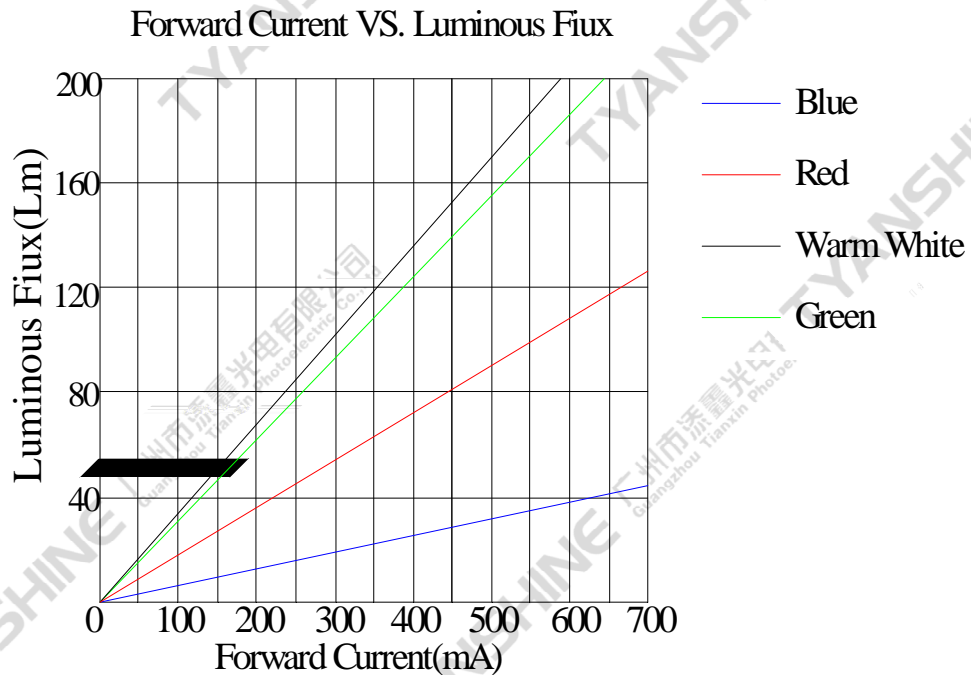
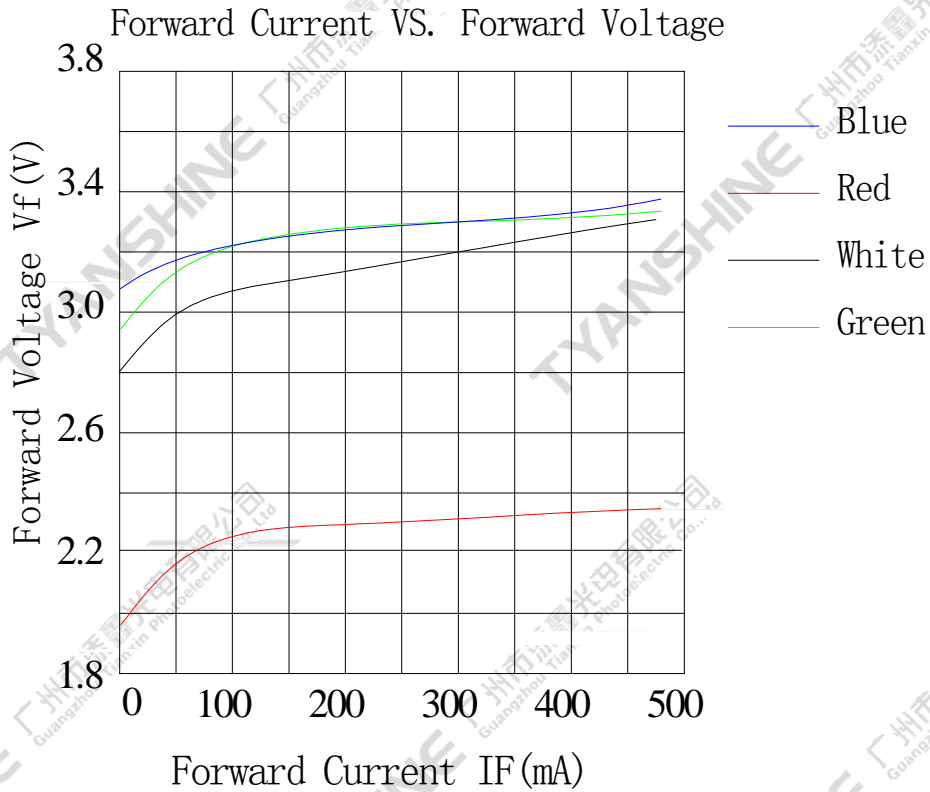



Ambient Temperature vs. Forward Current

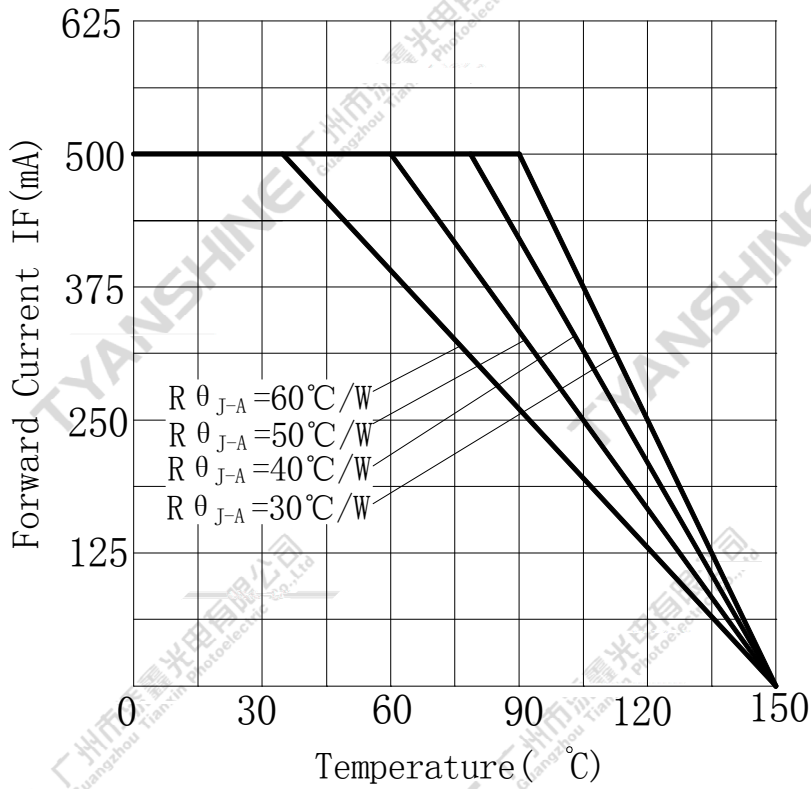

Spectral Radiance: Red Peak@632nm
Green Peak@519nm
Blue Peak@455nm

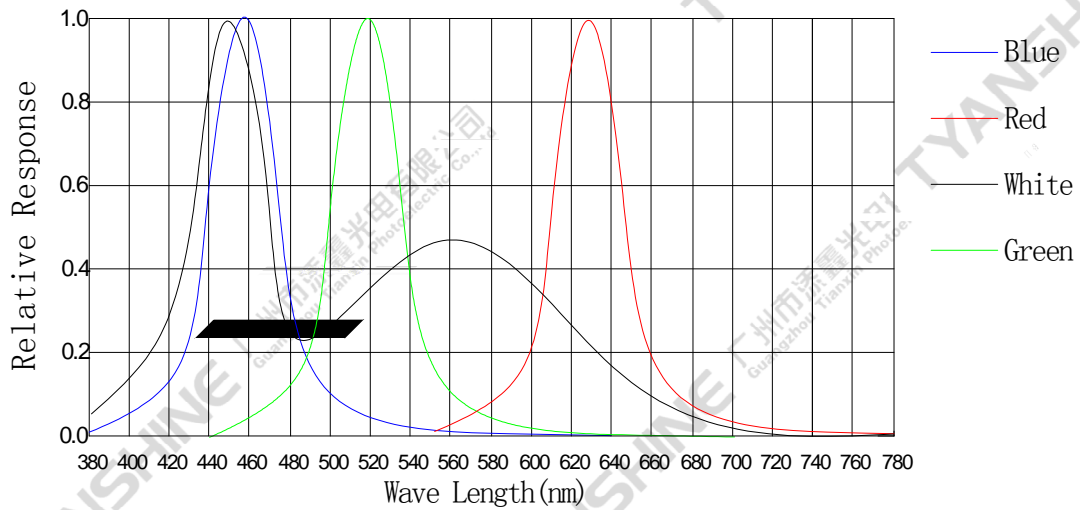

TYANSHINE 广州市添鑫光电有限公司
Guangzhou Tianxin Photoelectric Co., Ltd.

TYANSHINE 广州市添鑫光电有限公司
Guangzhou Tianxin Photoelectric Co., Ltd.

TYANSHINE 广州市添鑫光电有限公司
Guangzhou Tianxin Photoelectric Co., Ltd.

TYANSHINE 广州市添鑫光电有限公司
Guangzhou Tianxin Photoelectric Co., Ltd.

TYANSHINE 广州市添鑫光电有限公司
Guangzhou Tianxin Photoelectric Co., Ltd.

广州市添鑫光电有限公司
Guangzhou Tianxin Photoelectric Co., Ltd.

TYANSHINE 广州市添鑫光电有限公司
Guangzhou Tianxin Photoelectric Co., Ltd.

TYANSHINE 广州市添鑫光电有限公司
Guangzhou Tianxin Photoelectric Co., Ltd.

